



KWIKCLAMP[®]

- brilliantly simple!



-  **Clamp fittings**
-  **Barrier Panels**
-  **Posts, end terminations, toe plates**
-  **AS1657 certified & AS1428 compliant**

1300 59 00 59

www.kwikclamp.com.au

Complete range of clamps, barrier panels, posts, rails, toe plates for all sorts of safety barrier applications
 – check online or call 1300 59 00 59 for more information

The Kwikclamp® range of modular fittings, posts, rails, end terminations, barrier panels, bollards, stanchions and accessories all comply with the design requirements of AS1657 and AS1428, the Australian Standards for safety barriers and handrails in a multitude of applications. All products are hot dip galvanised to comply with AS4680 and have a minimum of 500gsm zinc coating plus a further protective electroplating coating.

Clamp products are made from high quality 450 MPa heat treated steel. Available in B34, C42, D48 and E60 sizes (*limited selection of B34 and E60 items*), Kwikclamp's fittings are made from malleable or ductile iron with all new production using case hardened 15mm long 316 grade stainless steel screws for extra durability, vibration and corrosion resistance in the toughest conditions.

Tube Size Guide

Size Reference	Tube OD (mm)	Nominal Size (mm)
B-34	33.7	25NB
C-42	42.4	32NB
D-48	48.3	40NB
E-60	60.3	50NB



Construction Guide

The following illustrations are a guide for installing different types of handrail systems.

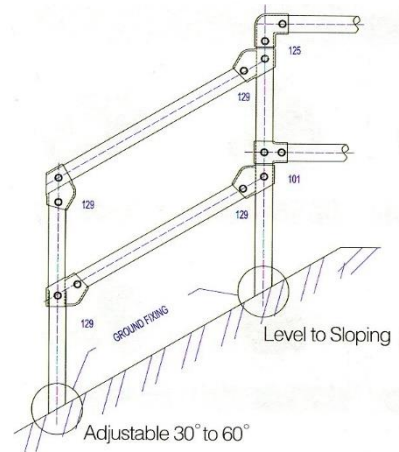
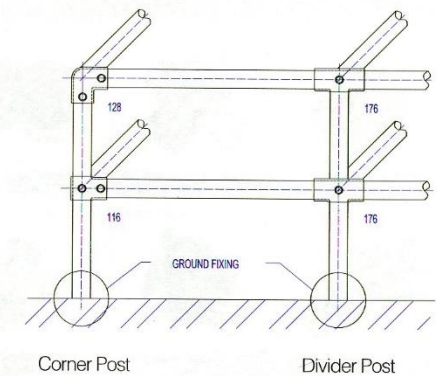
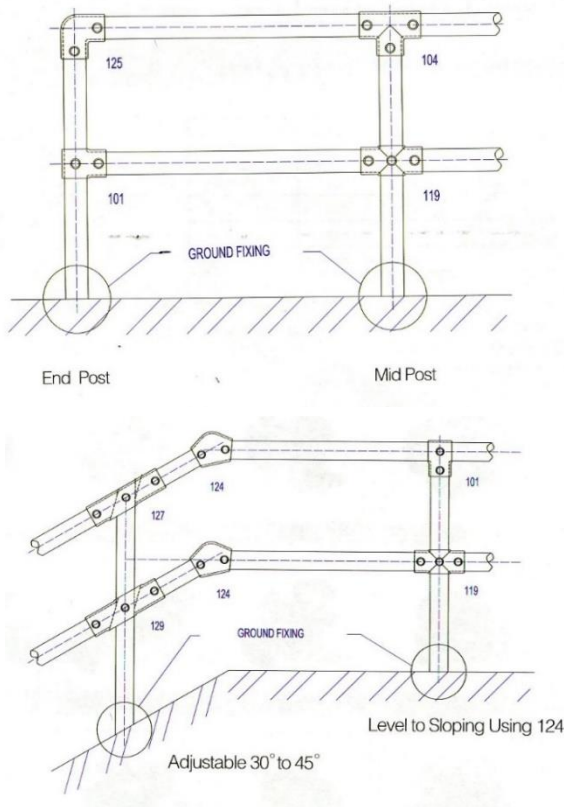

Check with your designer or specifier before using these possible configurations for any given application.

All Kwikclamp barrier panel products are hot dip galvanised for longer life, not all items and sizes are held in stock – check online or call 1300 59 00 59 for more information

Kwikclamp products are used in a multitude of applications, initially designed for the safety barrier and handrail markets; the modular nature of the clamps has given rise to very creative and highly functional applications that include but are not limited to ...

- Bikeway and pedestrian safety barrier systems
- Disability handrails
- Trolley parking & storage bays
- Mezzanine floor safety barriers & sliding pallet gates
- Road signs
- Retail displays & racking
- Exhibition stands & displays
- General signage
- Fall prevention systems, commercial, industrial & factory safety barriers
- Machinery enclosures & guards
- Roof and walkway guard rails

There are almost infinite number of ways of using the Kwikclamp fittings, barrier panels and accessories to quickly and easily create rigid structures with minimal need for tools and labour. The simple, modular nature of Kwikclamp products makes for less expensive erection of barriers compared to traditional welded or ball type designs.

All Kwikclamp fittings, posts, rails and barrier panels have been independently tested to comply with AS1657 for 2.4m post spacing – the Australian Standard for fixed platforms walkways and stairways as well as complying with AS4680 – galvanising.

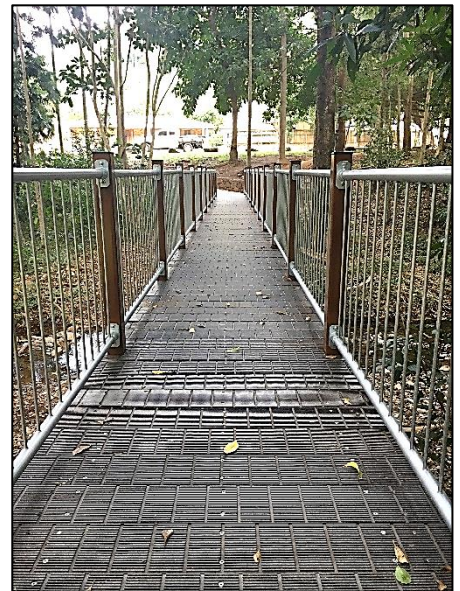



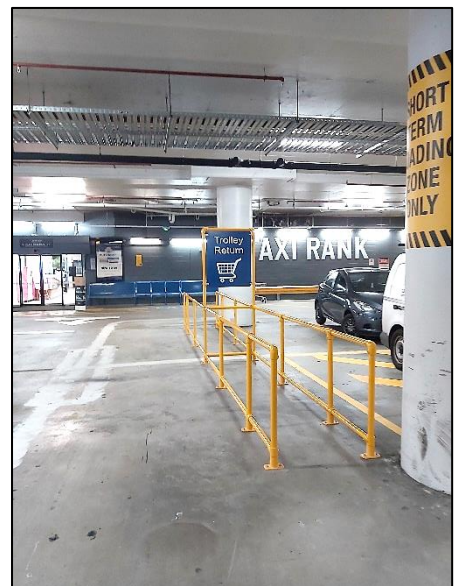















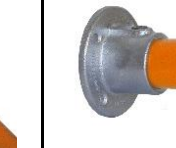















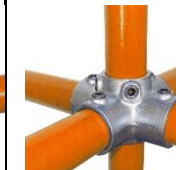
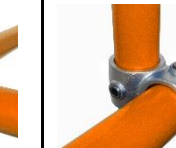



- Cost effective
- Fast to erect
- 50 year design life
- 5 year warranty (*subject to conditions*)
- Best value modular system available – certified to 2.4m widths
- Panels and rails comply with BSD7006, AS1657 specifications and AS1428 Disability Design guidelines



All clamp fittings are hot dip galvanised plus an extra protective top zinc coating for longer life, not all items and sizes are held in stock and more items are regularly being added to the range – check online or call 1300 59 00 59 for more information

The Kwikclamp Clamp Range

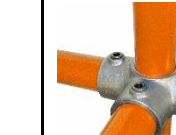
 101 Short Tee	 104 Long Tee	 116 3 Way Thru	 119 2 Socket Cross	 123 Variable Top Elbow 30-45°	 124 Variable Elbow 30-45°
 125 2 Way 90° Elbow	 127 Long Tee 30-45°	 128 3 Way 90° Elbow Tee	 129 Adjustable Short Tee 30-45°	 130 30°-45° Cross	 131 Base Wall & Floor Flange
 132 Base Flange (B34 & C42 only)	 133 Plastic End Cap	 138 Gate Eye	 139 Slimline Wall bracket	 140 Gate Hinge	 145 Railing Side Support
 146 Side Palm Fixing	 148 Short Tee Swivel (used in pairs, sold singly)	 149 External Sleeve Joiner	 150 Internal Sleeve Joiner (expanding)	 151 Internal Fixed Sleeve Joiner	 152 Base Flange 0-11°
 153 Short Tee 0-11°	 154 Elbow 0-11°	 155 Long Tee 0-11°	 156 Cross 0-11°	 158 5 way Cross	 161 Cross over
 166 Adjustable Swivel	 167M Double Male Inline Swivel	 167 Double Swivel Combination (173F x 2 + 167M)	 168M Male Corner Swivel	 168 Corner Swivel Assembly (173F x 2 + 168M)	 169 Swivel Base (shown as an assembly with a 173F)
 172M Male Swivel	 172 Swivel Assembly (173F + 172M)	 173 Single Swivel Combination (173M + 173F)	 173F Female Swivel	 173M Single Male Swivel	 176 4 Way Side Outlet Cross

All clamp fittings are hot dip galvanised plus an extra protective top coating for longer life, not all items and sizes are held in stock and more items are regularly being added to the range – check online or call 1300 59 00 59 for more information

 177 4 Way Side Outlet Tee	 179 Locking Collar	 198 Double Fixing Bracket	 199 Single Fixing Bracket	 232 Rectangular Flange Base (D48 & E60 only)	 233 Square Base Flange (D48 & E60 only)
 235 Sleeved wall bracket	 242 Kickplate Flange (D48 only)	 246 Side Flange	 251 Base Flange 30-45°	 252 Base Flange 11-29°	 253 Short Tee 11-29°
 255 Long Tee 11-29°	 256 Cross 11-29°	 300 Replacement grub screws (5/16" x 15mm long – 316 grade stainless)	 333 Alloy End Cap	 304 Security Screw Plug (Knock in plug – fits 5/16" grub screw inner)	
KWIKCLAMP DDA ASSIST CLAMP RANGE					
Smooth inline handrail clamps designed to comply with AS1428 – disability access design guide.					
 725 Internal 90 degree Corner Fixed Sleeve Joiner	 746 Support Wall Bracket – small & large wall plates. Takes 32 & 40NB handrail pipe	 748 Support Bracket (Takes 32 & 40NB handrail pipe)	 751 Rail support Assembly (751 saddle + 173F)	 752 Offset Rail Support Assembly (752 offset saddle + 173F)	 764 Variable Angle Elbow Fixed Sleeve Joiner
 797 "O" Ring	 301 Allen Keys	 D End termination	 J End Termination	 Extruded aluminium kick plate system	

All pipe & plate products are hot dip galvanised for longer life, not all items and sizes are held in stock and more items are regularly being added to the range – check online or call 1300 59 00 59 for more information

Kwikclamp supplies a range of posts, rails, end terminations and toe plates in various lengths and configurations. The vast majority of safety handrails are 40NB medium pipe (48.3 OD x 3.2mm) with cranked post tops suited to AS1428 and Cycle Australia design guidelines. We can also have custom designs made for large scale projects where we are indeed very experienced in delivering top quality product at excellent value.

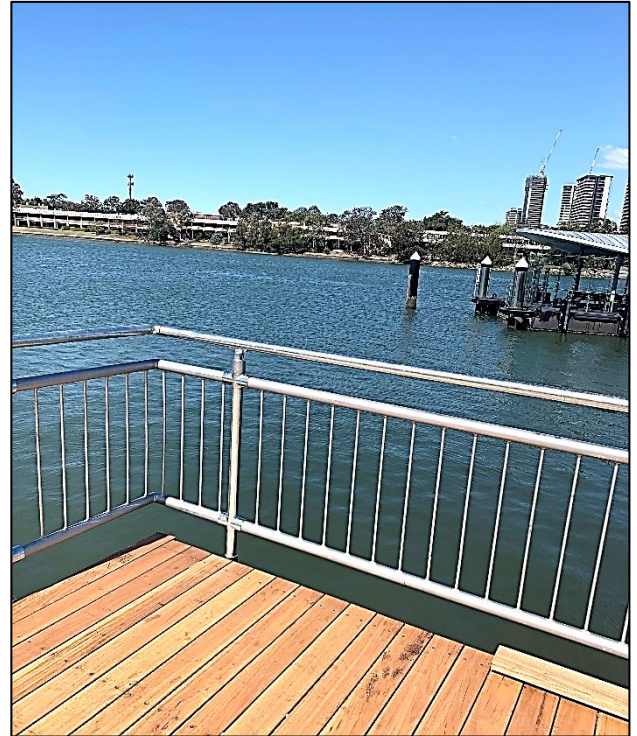

Custom Design Extruded Aluminium Kickplate

Notes:-

- Not all clamp items are available in all sizes – check online or call **1300 59 00 59** for availability
- Powder coated finishes are available on special request (*minimum order quantities and charges apply*)
- All specifications, designs and dimensions are subject to change without notice
- All new Kwikclamp fittings use 316 grade stainless steel screws for superior corrosion resistance

All barrier panel products are hot dip galvanised for longer life, not all items and sizes are held in stock and more items are regularly being added to the range – check online or call 1300 59 00 59 for more information



Barrier panels – 2000mm wide x 1000mm high

Kwikclamp barrier panels and handrail systems have been independently tested to comply with AS1657 and also comply with Cycling Australia design guidelines. Typical hot dip galv coating is around 90-120 microns – far in excess of the Australian Standard requirement of 70 microns (500gsm).

We can have any design, incline angle panel made to order, call us to enable us to help you get what you need for your projects.



Mezzanine floor sliding gate kits

Bikeway & Pedestrian panels – same length top & bottom rails

- Designed for use with extend posts and 119 CROSS fittings
- End “D” and “J” termination sections also available
- Designed for use with 104 TEE joiner and 119 CROSS fittings
- 2000mm width panels in 1000mm heights
- 40NB medium (3.2mm) top & bottom rails
- 12mm & 16mm solid rod pickets, continuous weld of rod to rail @ 100mm centres
- Hot dip galv to exceed AS4680 after welding
- Inclined versions available for ramps and stairs
- 2.4m wide panels are certified for AS1657 compliance

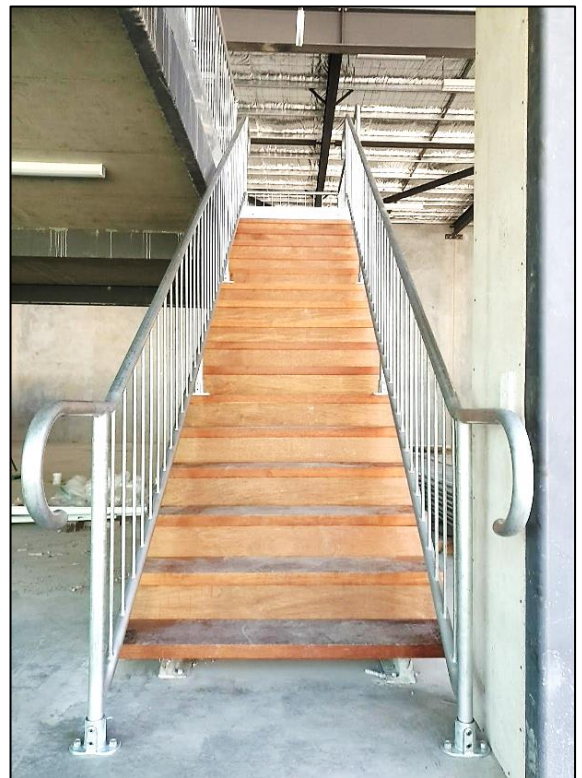

Kwikclamp Bollard Systems - Surface mount & inground options

AS1657 & AS1428 Compliance Certified – quality you can rely on!

Kwikclamp barrier systems have been independently tested and certified by LMATS, a NATA registered testing authority, for compliance with AS1657 – the Australian Standard for the design, construction and installation of walkway and stairway barriers. Certification is for panels and handrails at 2.4m post spacing for D48 (40NB) size rails, posts and fittings which means that pedestrian and bikeway barriers and safety handrails can be erected at 2.4m post spacing:-

- Fewer posts, fasteners and fittings
- Less labour and faster installation times
- Far lower total cost than other modular barrier systems that can only be used in 1800 and 2000mm wide post spacing to comply with AS1657

A copy of the LMATS test report and AS1657 certification can be downloaded from the Kwikclamp website (www.kwikclamp.com.au). Check the website for other certifications that will become available from time to time.

- AS1428 Disability Design guidelines compliant

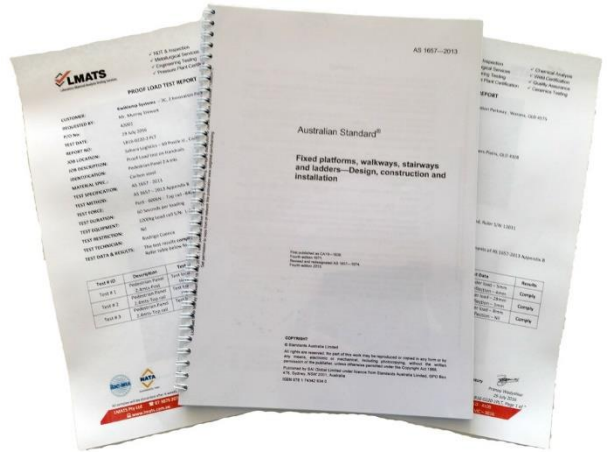

So when you need a very competitive and complete system of superior clamps, barrier panels, posts and rails, Kwikclamp has what you need backed with responsive, reliable service and distributors Australia wide. Find your nearest supplier online to or call us for assistance.

